



Inductive sensor NBN3-F31K2-Z8L-B13-S

- Direct mounting on standard actuators
- Compatible with all process control systems
- Weatherproof housing for outdoor applications
- Temperature range -40 ... 167 °F (-40°C to 75°C)
- 2-wire DC sensor with minimum off-state current
- LEDs for switching state of sensor and solenoid valve
- Plug-in terminals



Installation

The connections to this sensor are sealed with stopping plugs to protect against dirt and moisture. If not all of the connections are used in your application, then seal the remaining stopping plugs on the sensor permanently or check during initial installation and when performing regular maintenance work that the stopping plugs are secure and impermeable. If necessary, tighten the stopping plugs to a torque of 1 Nm.

Dimensions

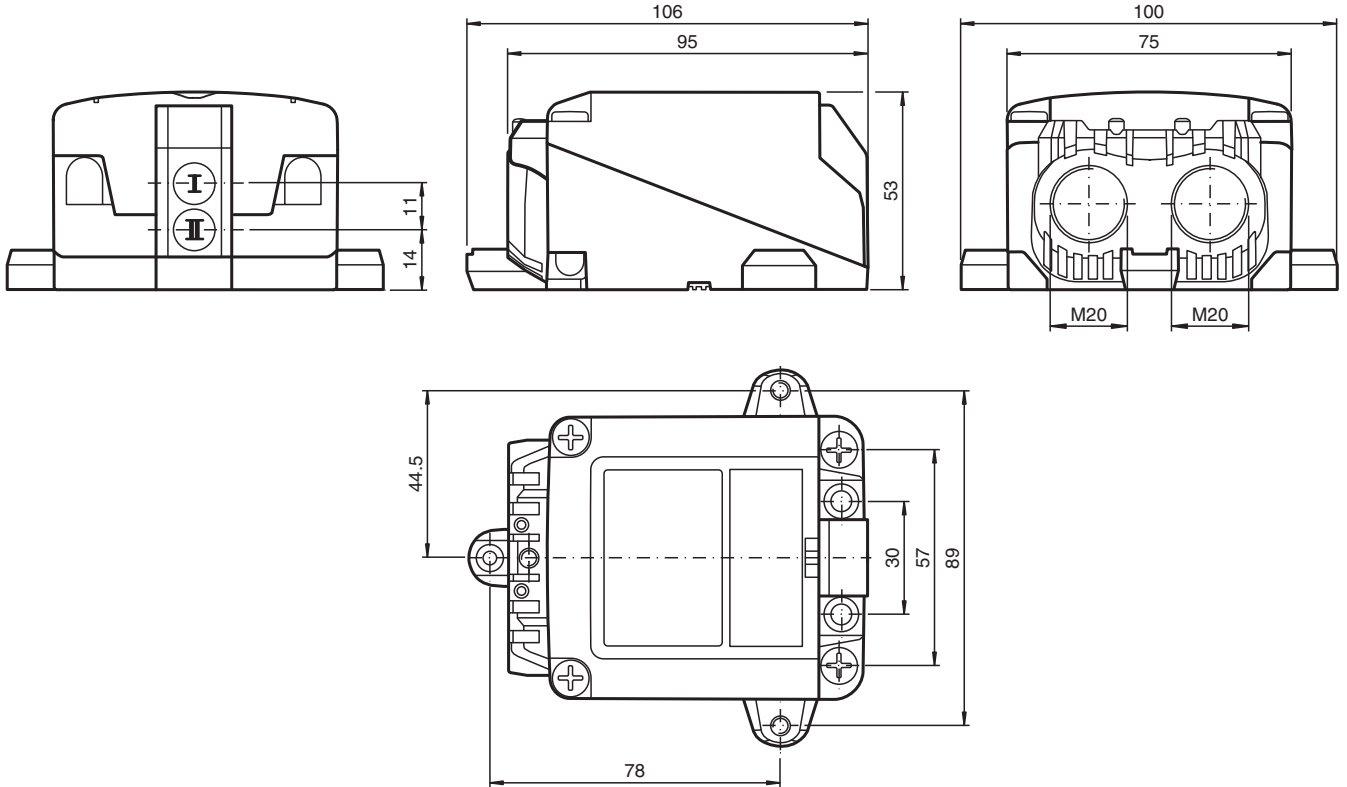

Technical Data



General specifications		
Switching function		2 x normally open (NO)
Output type		Two-wire with minimum off-state current
Rated operating distance	s_n	2.5 mm
Installation		for non-flush mounting
Output polarity		DC
Assured operating distance	s_a	0 ... 2.05 mm
Output type		2x 2-wire
Nominal ratings		
Operating voltage	U_B	6 ... 30 V
Switching frequency	f	0 ... 100 Hz
Hysteresis	H	typ. 0.5 mm
Reverse polarity protection		reverse polarity tolerant
Short-circuit protection		no
Voltage drop	U_d	≤ 6 V
Operating current	I_L	4 ... 100 mA
Off-state current	I_r	100 ... 200 μ A typ. 160 μ A
Switching state indicator		LED, yellow
Valve status indicator		LED, yellow
Functional safety related parameters		
MTTF _d		684 a
Mission Time (T _M)		20 a
Diagnostic Coverage (DC)		0 %
Valve circuit		
Voltage		max. 32 V DC
Current		max. 240 mA
Short-circuit protection		no
Reverse polarity protection		yes, with reversed output LED is out of function, therefore more power for solenoid valve
Compliance with standards and directives		
Standard conformity		
Standards		EN 60947-5-2:2007 EN 60947-5-2/A1:2012 IEC 60947-5-2:2007 IEC 60947-5-2 AMD 1:2012 VDI / VDE 3845
Approvals and certificates		
UL approval		cULus Listed, General Purpose, Class 2 Power Source
Ambient conditions		
Ambient temperature		-40 ... 75 °C (-40 ... 167 °F)
Storage temperature		-40 ... 85 °C (-40 ... 185 °F)
Mechanical specifications		
Connection (system side)		screw terminal , M20 x 1.5 cable gland
Core cross section (system side)		1.5/2.5 mm ² flexible/rigid
Connection (valve side)		screw terminal , Cable gland M20 x 1.5
Housing material		rugged, translucent polycarbonate (PC) optimised for outdoor use
Housing base		PC
Degree of protection		IP66 / IP68 / IP69
Tightening torque, fastening screws		4 Nm ... 5 Nm
Tightening torque, housing screws		≤ 2 Nm
Tightening torque of cover screws		1.5 Nm
Tightening torque, cable gland		M20 x 1.5 ; max. 7 Nm
Tightening torque, stopping plug		1 Nm

Release date: 2023-05-09 Date of issue: 2023-05-09 Filename: 235082_eng.pdf

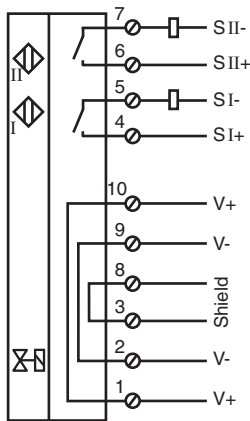

Connection



Matching System Components

	BT115A	Activator for F31 series
	BT115X	Activator for F31 series

Accessories

	BT65-F31K2-RG-EN	Activator for F31K2 series
	BT65A	Activator for F31 series
	BT65X	Activator for F31 series

Release date: 2023-05-09 Date of issue: 2023-05-09 Filename: 235082_eng.pdf